

1、产品概要 / Outline

- ◆ 磁屏蔽结构，有较强抗干扰性能
- ◆ 正方形构造适合高密度贴装
- ◆ 耐大电流低阻值
- ◆ 工作温度：-40°C ~ +125°C
- ◆ 主要应用于照明行业、通信设备、计算机行业、安防行业、
- ◆ 智能家居行业、家用电器、电子产品等

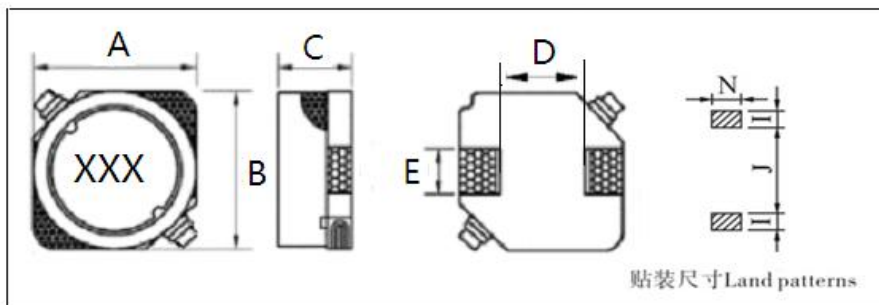

◆ 2、外观尺寸/ Appearance size 单位:mm

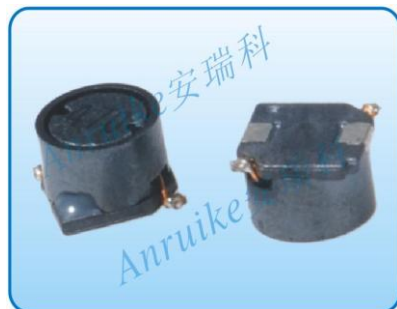

A	B	C	D	E	N	I	J
10.0±0.3	10.0±0.3	3.0±0.3	6.0	3.2	3.2	2.5	5.6

3、电气特性/Electrical characteristics

型号/NO	L/uH	DCR (Ω)		Irms(A)	Isat(A)
		Typ	Max		
ADBL1030-100M	10	0.07	0.10	2.00	2.5
ADBL1030-120M	12	0.07	0.12	1.90	2.3
ADBL1030-150M	15	0.08	0.15	1.70	2.0
ADBL1030-220M	22	0.12	0.20	1.30	1.7
ADBL1030-270M	27	0.15	0.25	1.15	1.5
ADBL1030-330M	33	0.21	0.30	1.10	1.5
ADBL1030-470M	47	0.30	0.51	0.85	1.20
ADBL1030-680M	68	0.58	0.85	0.75	1.0
ADBL1030-101M	100	0.67	1.00	0.60	0.90
ADBL1030-151M	150	0.79	1.25	0.50	0.84
ADBL1030-221M	220	1.35	1.65	0.40	0.80
ADBL1030-331M	330	2.00	2.00	0.32	0.68
ADBL1030-471M	470	3.50	4.50	0.28	0.50
ADBL1030-681M	680	4.10	5.50	0.22	0.40
ADBL1030-102M	1000	5.10	6.85	0.18	0.35

注释

- ◆ K 表示电感值的公差为±10%，M 表示电感值的公差为±20%，N 表示电感值的公差为±30%
- ◆ K said inductance tolerance is ±10%, M said inductance tolerance is ± 20%
- ◆ 所有数据基于环境温度 25°C条件下测试
- ◆ All data is based on testing at an ambient temperature of 25 °C
- ◆ 测试条件：100KHz/0.25V
- ◆ 本页面未能录入全部或最新的数据，请您在订购前向本公司咨询精准参数及样品。
- ◆ We were unable to input all or the latest data on this page. Please consult our company for accurate parameters and samples before placing an order.

4 包装规格/ Packaging specifications 单位/m

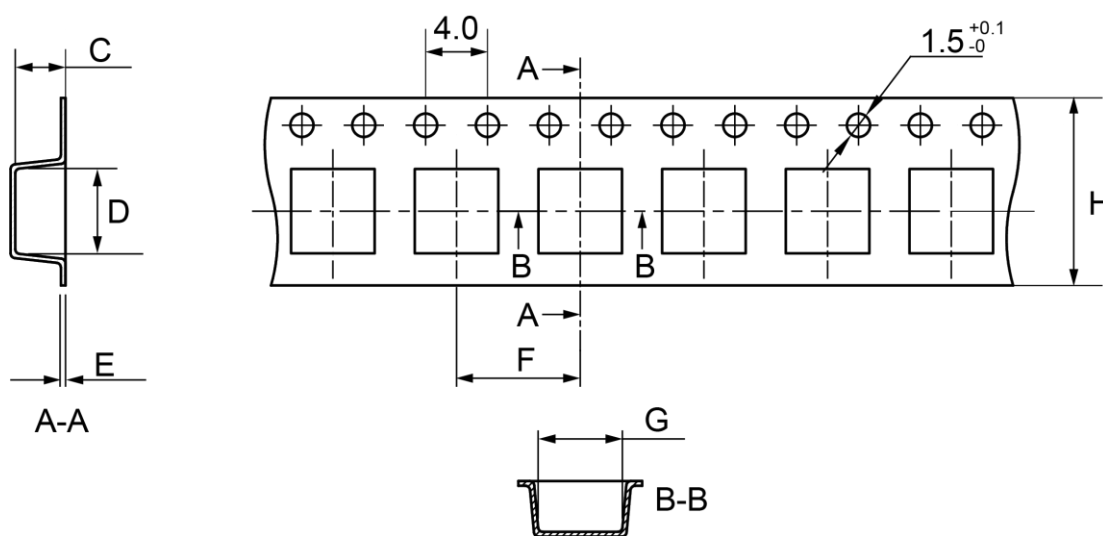

型号	C	D	E	F	G	H
ADBL0735	3.65±0.1	7.7±0.1	0.35±0.05	12.0±0.1	7.7±0.1	16.0±0.3
ADBL0750	4.8±0.1	7.8±0.1	0.35±0.05	12.0±0.1	7.8±0.1	16.0±0.3
ADBL1045	4.75±0.1	10.8±0.1	0.35±0.05	16.0±0.1	10.8±0.1	24.0±0.3
ADBL1270	8.1±0.1	12.8±0.1	0.35±0.05	16.0±0.1	12.8±0.1	24.0±0.3

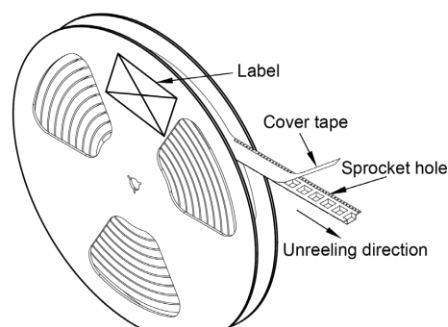
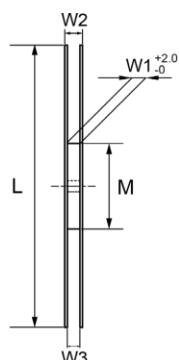
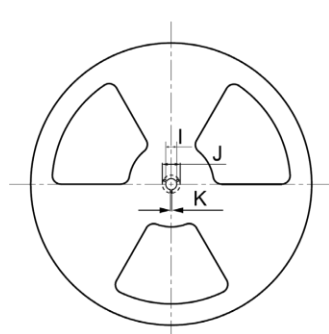
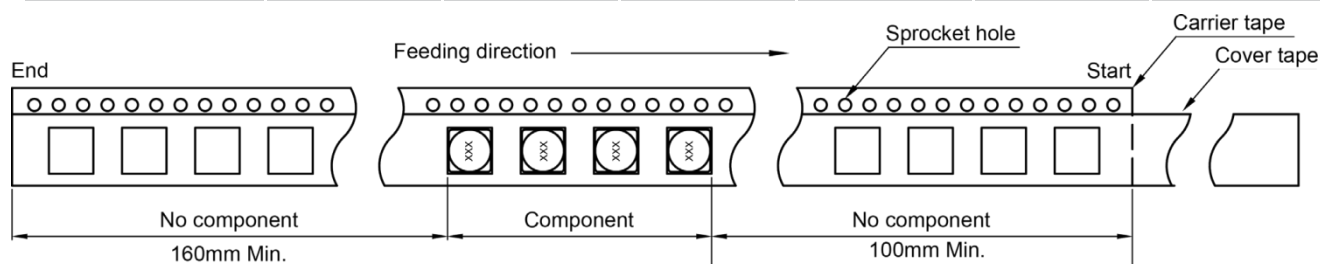

型号	数量	I	J	K	L	M	W1	W2	W3
ADBL0735	1000pcs	13.0±0.5	21.0±0.8	2.0±0.5	330±2.0	100Min.	16.4	22.40Max	15.90Min
ADBL0750	1000pcs	13.0±0.5	21.0±0.8	2.0±0.5	330±2.0	100Min.	16.4	22.40Max	15.90Min
ADBL1045	800pcs	13.0±0.5	21.0±0.8	2.0±0.5	330±2.0	100Min.	24.4	30.40Max.	23.90Min.
ADBL1270	500pcs	13.0±0.5	21.0±0.8	2.0±0.5	330±2.0	100Min.	16.4	22.40Max.	15.90Min.

5、焊接/welding

• 焊接原材料 Soldering Materials

(a) 焊料：推荐使用 96.5Sn/3.0Ag/0.5Cu 焊料，或者采用 Sn 含量不超过 97%的锡合金焊料。Solder: It is recommended to use 96.5Sn/3.0Ag/0.5Cu solder, or use Tin alloy solder with a Tin content not exceeding 97%.

(b) 助焊剂：推荐使用松香类助焊剂，请勿使用强酸性助焊剂（含氯量超过 0.2wt %），并且请勿使用水溶性助焊剂。

Flux: It is recommended to use rosin-based flux. Acidic flux (with chlorine content exceeding 0.2wt %) and water-soluble flux are forbidden.

• 焊接温度及要求 Soldering Temperature & Requirements

(1) 回流焊 Reflow Soldering

回流焊温度曲线 Reflow Soldering Temperature Profile

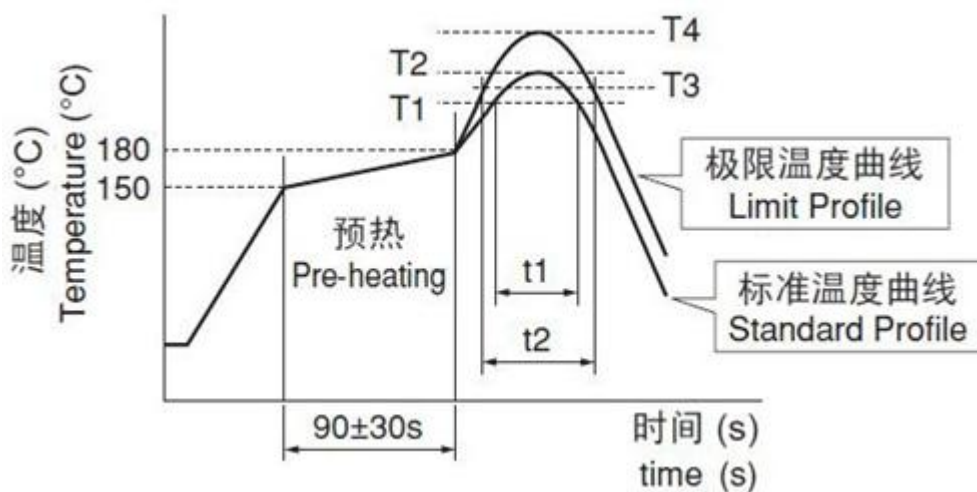

回流焊要求 Reflow Soldering Requirements

标准温度曲线Standard Profile				极限温度曲线Limit Profile			
加热Heating		峰值温度 Peak Temp. (T2)	回流焊 次Cycle Of	加热Heating		峰值温度 Peak Temp. (T4)	回流焊次数 Cycle Of Reflow
加热 Tem p. (T1)	时间 Time (t1)			温度 Temp. (T3)	时间 Time (t2)		

			Reflow				
220°C	30~60s	245±3°C	≤2	230°C	≤60s	260°C/10s	1

(2)、波峰焊 Flow Soldering

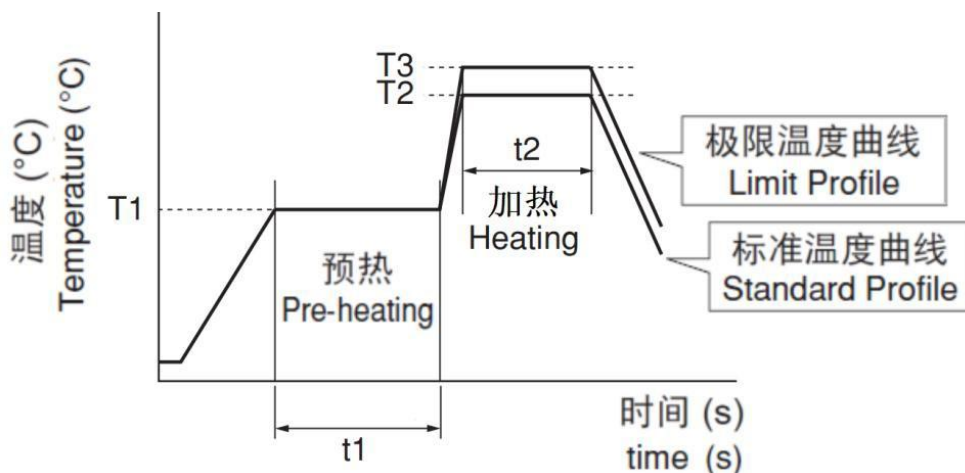

波峰焊要求Flow Soldering Requirements

预热 Pre-heating		标准温度曲线 Standard Profile			极限温度曲线Limit Profile		
		加热Heating		波峰次数 Cycle Of Flow	加热		波峰次数 Cycle Of Flow
温度 Temp (T1)	时间 Time (t1)	温度 Temp (t2)	时间 Time (t2)		温度 Temp. (T3)	时间 Time (t2)	
150°C	≥60s	250°C	4s ~ 6s	≤2	265±3°C	≤5s	1

6、其他

- ◆ 本产品为无铅，请采用无铅环境作业
- ◆ Other: Our company's products are lead-free, please operate in a lead-free environment
- ◆ 由于页面限制，更多资料请联系我司
- ◆ Due to page limitations, please contact our company for more information
- ◆ 在过载电流等不正常条件下，本电感产品无自我保护功能。
- ◆ Under abnormal conditions such as overload current, this inductor product has no self-protection function.

- ◆ 贮藏温度：10°C ~ 25°C，相对湿度：65% ~ 85%。
- ◆ Storage temperature: 10 °C~25 °C, relative humidity: 65%~85%

电感使用注意事项

Precautions for using inductors

1、**环境条件**：电感的使用环境对其性能有重要影响。潮湿与干燥、环境温度的高低、高频或低频环境等都需要特别注意。

Environmental conditions: The usage environment of inductors has a significant impact on their performance. Special attention should be paid to factors such as humidity and dryness, high or low ambient temperatures, and high or low frequency environments

2、特殊环境尽可能选择安瑞科的一体成型电感，此类电感合金粉压铸，全密封结构。防潮、防腐蚀、耐高温较强

For special environments, it is recommended to choose Anruike's integrated inductors, which are made of alloy powder and have a fully sealed structure. Strong moisture resistance, corrosion resistance, and high temperature resistance

3、**频率特性**：在高频时，电感的阻抗特性会变得明显，可能会出现耗能发热、感性效应降低等现象。铁氧体材料在高频下会表现出较高的阻抗。

Frequency characteristics: At high frequencies, the impedance characteristics of inductors become apparent, and phenomena such as energy dissipation, heat generation, and reduced inductive effects may occur. Ferrite materials exhibit high impedance at high frequencies.

4、**电流和发热**：电感设计时要考虑其能承受的最大电流及其相应的发热情况。过载使用会导致电感失效。

Current and heat generation: When designing an inductor, the maximum current it can withstand and its corresponding heat generation situation should be considered. Overloading can cause the inductor to fail.

5、**保存条件**：电感在保存和使用时也需要注意环境条件。最佳安装保质期限为 6 个月，保存条件为密封包装、温度 $\leq 40^{\circ}\text{C}$ 、相对湿度 $\leq 70\%$ 。避免将产品保存在高温、高湿、有尘埃、腐蚀性气体的环境中。

Storage conditions: Inductors also need to pay attention to environmental conditions during storage and use. The optimal installation shelf life is 6 months, and the storage conditions are sealed packaging, temperature $\leq 40^{\circ}\text{C}$, and relative humidity $\leq 70\%$. Avoid storing the product in environments with high temperature, high humidity, dust, and corrosive gases.

6、**避免过载和不正常条件**：电感没有自我保护功能，不能在过载、高温、高压等不正常条件下使用。超规格的高电压绝缘测试会对产品造成损伤，缩短使用寿命。

Avoid overload and abnormal conditions: Inductors do not have self-protection functions and cannot be used under abnormal conditions such as overload, high temperature, and high voltage. Excessive high voltage insulation testing can cause damage to the product and shorten its service life.

7、导线裸露式电感（非屏蔽）应避免二次以上 SMT 作业，双面板应先焊接载有电感的板面。

Bare wire inductors (unshielded) should avoid secondary SMT operations, and double-sided boards should be soldered with the surface carrying the inductor first.